

•MAŁY KONSTRUKTOR•
•CONSTRUCTOR•
JUNIOR



4+

107



2589



SPOSÓB UŻYCIA NARZĘDZI

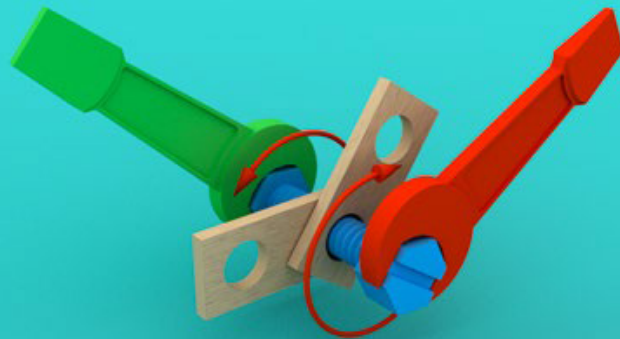
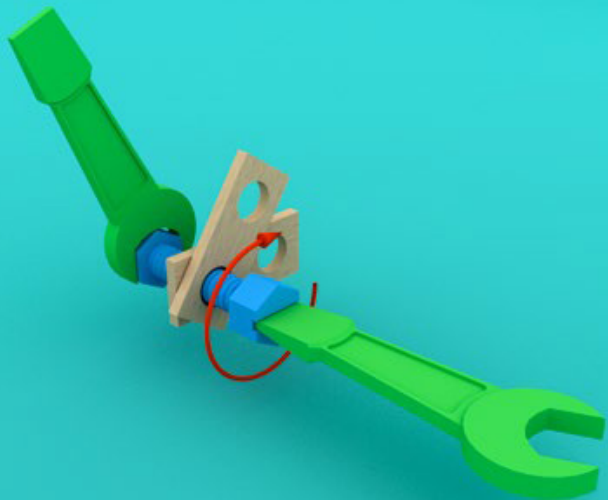



x 2



x 2



x 2

KP001

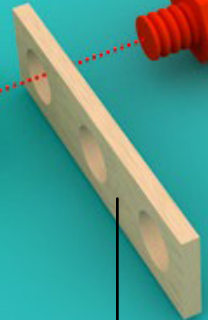

D03

SP001



KP001

D03

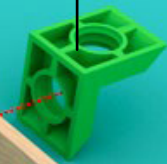
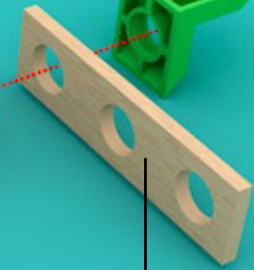

1

x 1



x 2



SP001

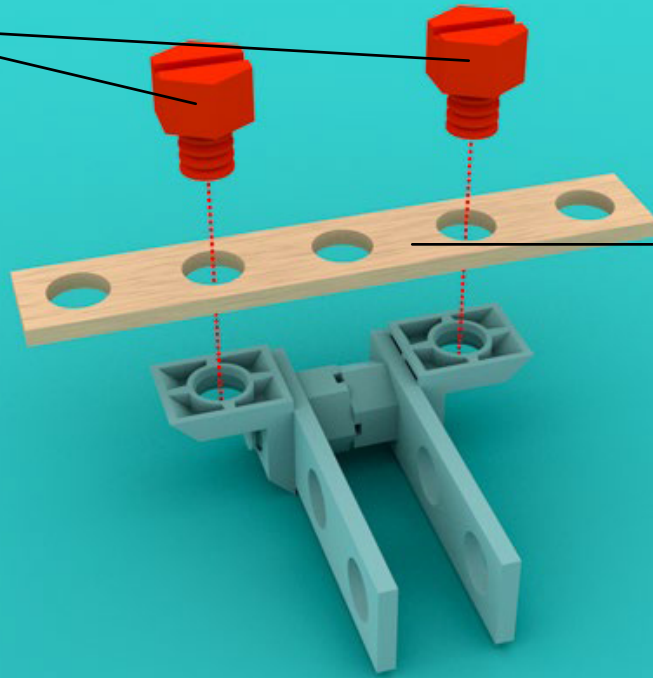

D05



x 2



x 2

x 2

SP001

KP001

DL02

DL02

KP001

3

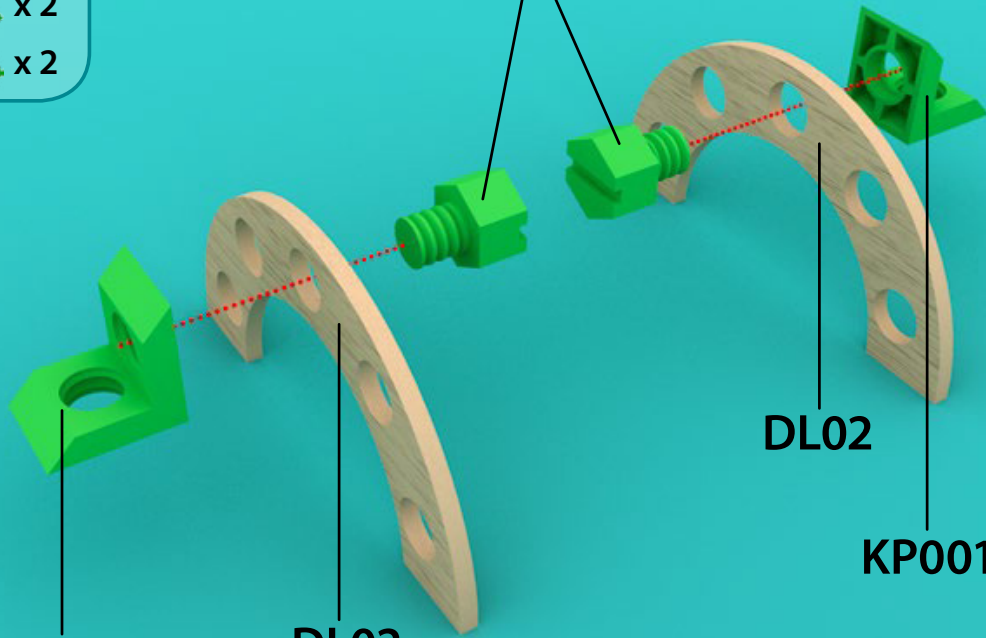

NP001

KP001

-  x 1
-  x 1
-  x 2

SP003

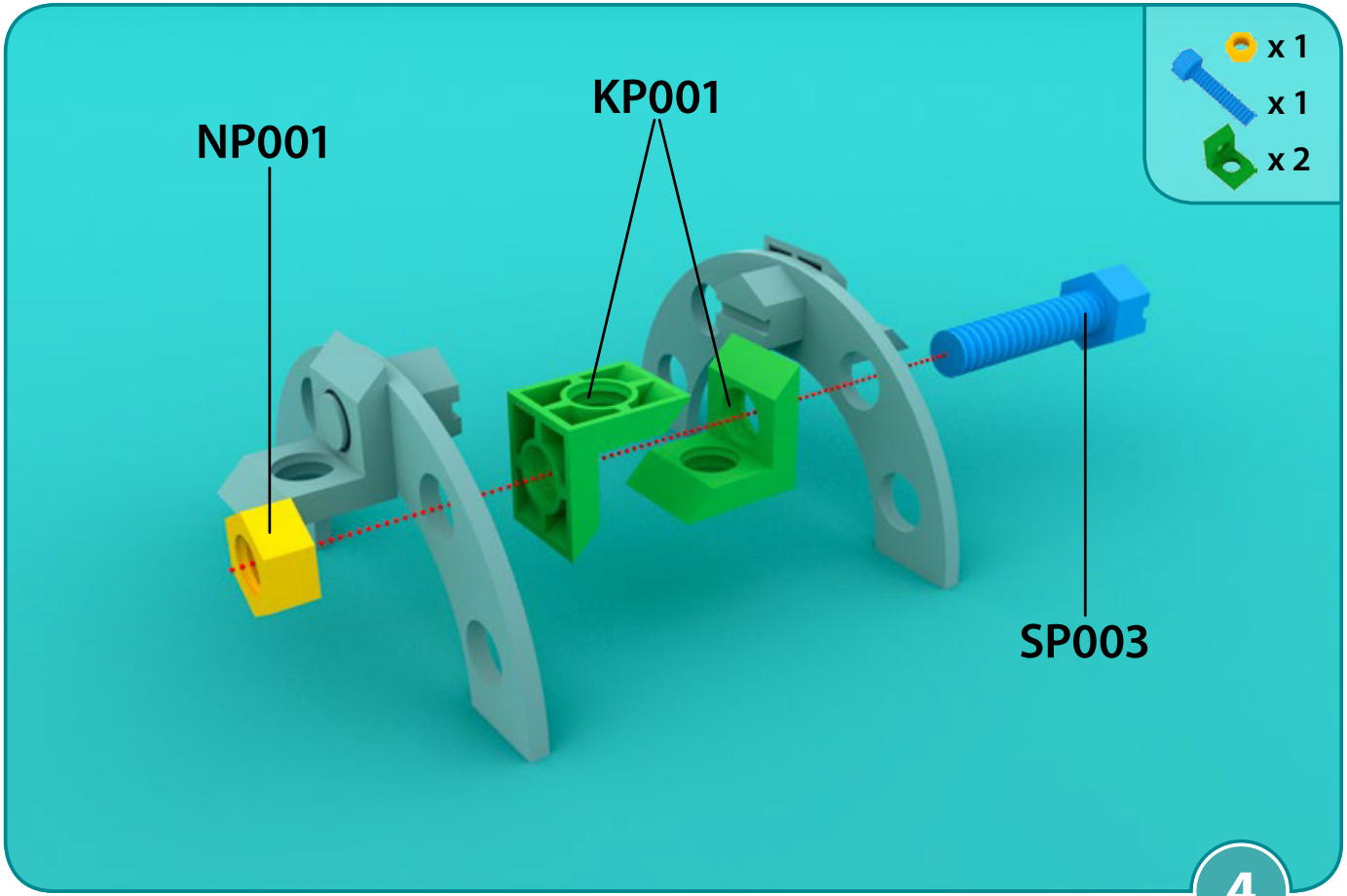

 x 1

 x 1

D02

SP001

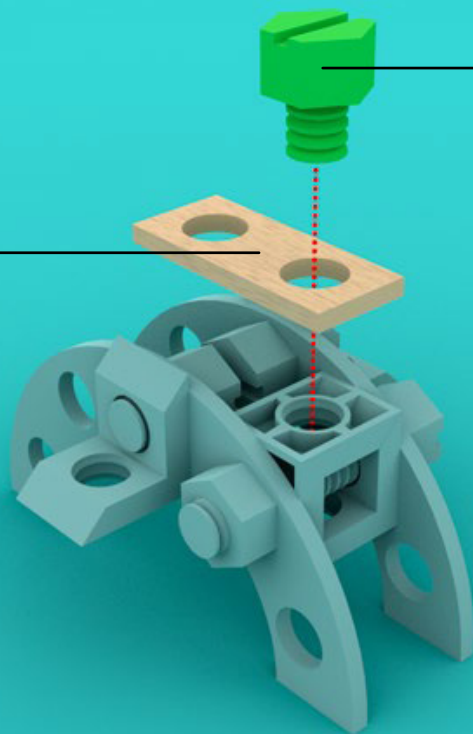

5

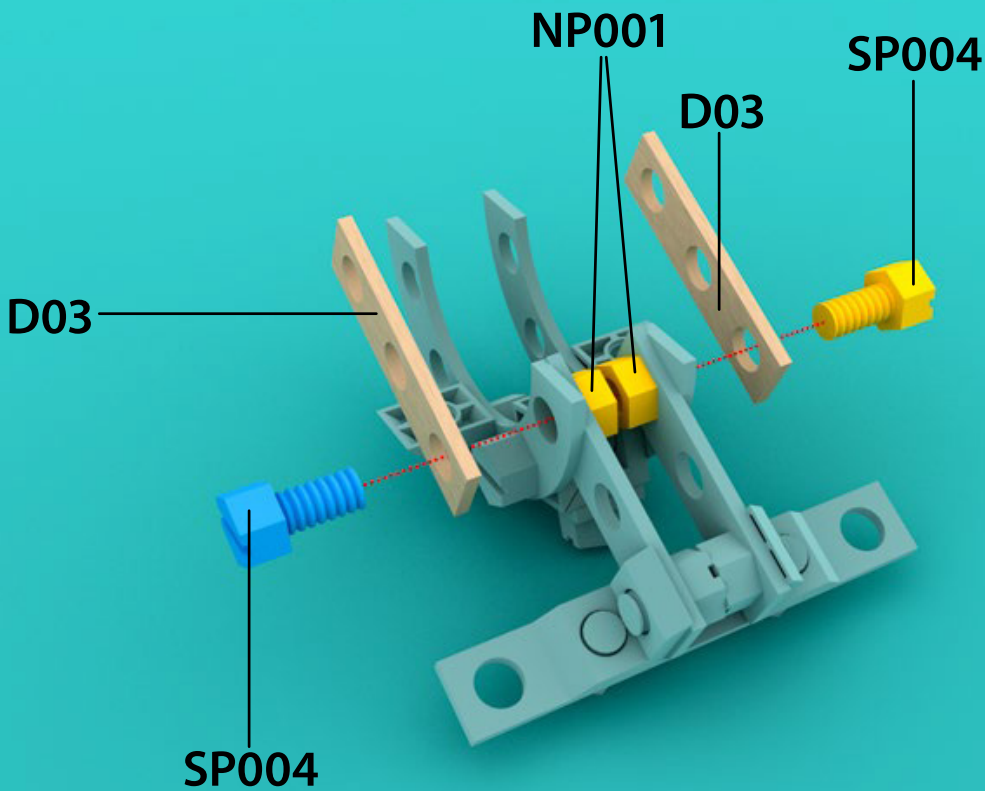

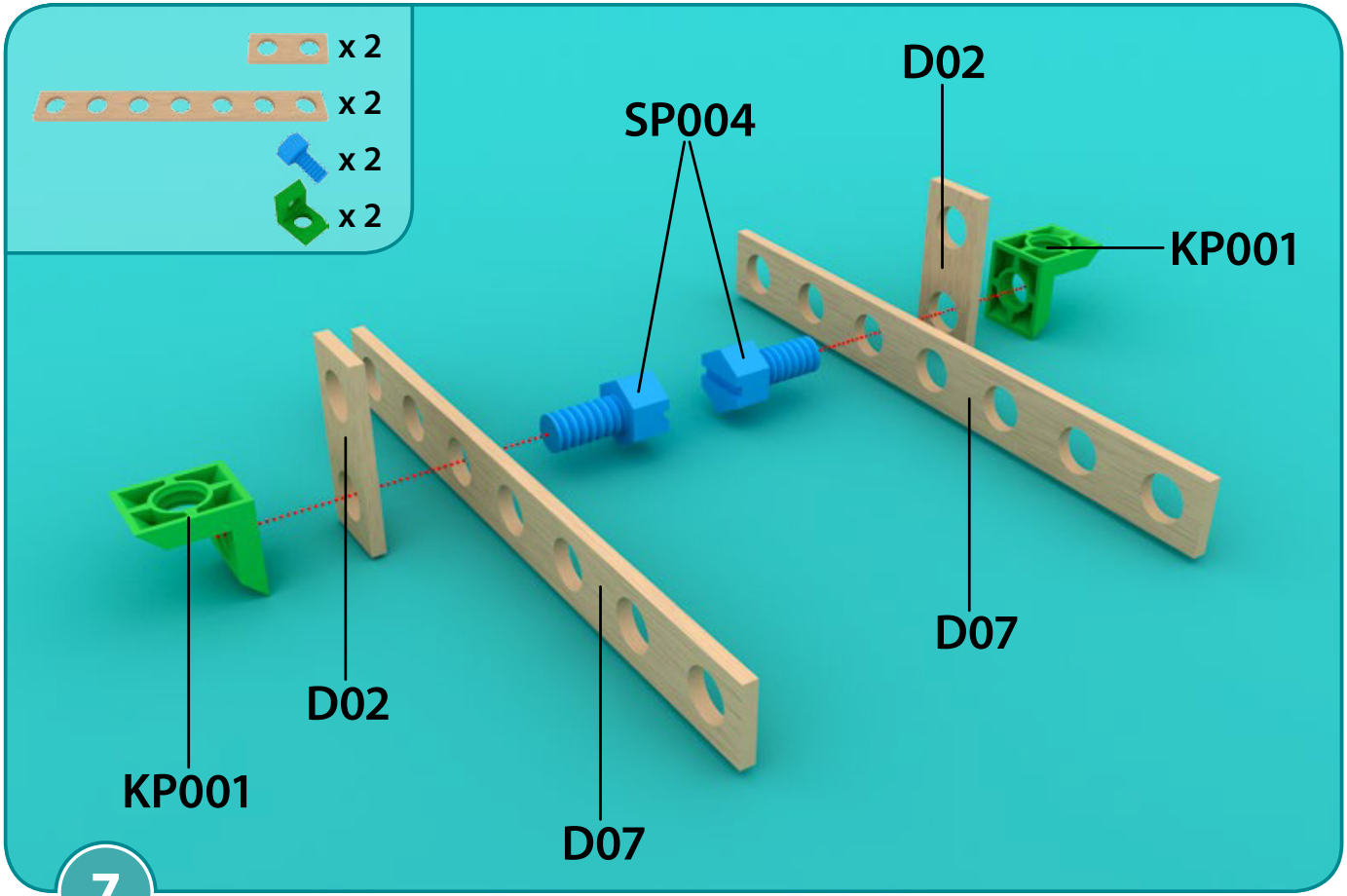

SP003

KP001

NP001

-  x 1
-  x 1
-  x 2

 x 1

 x 1

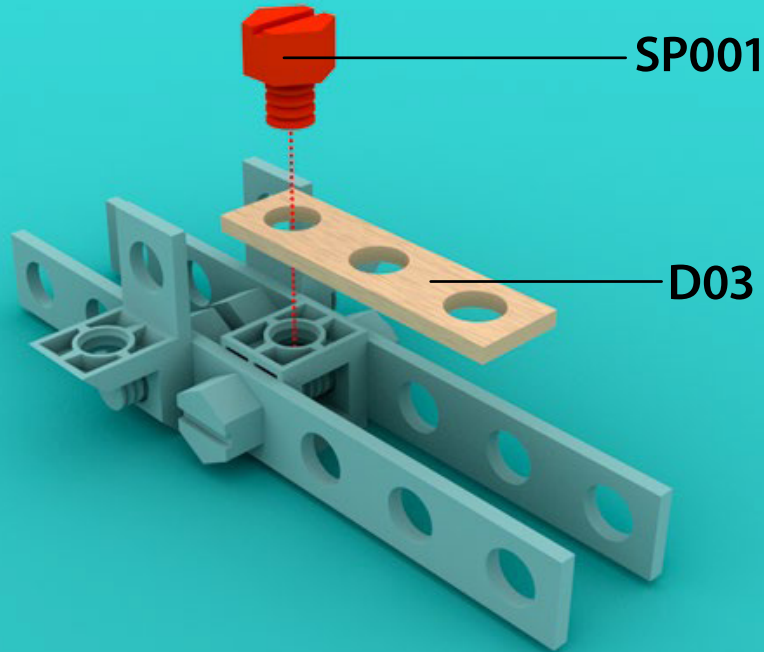

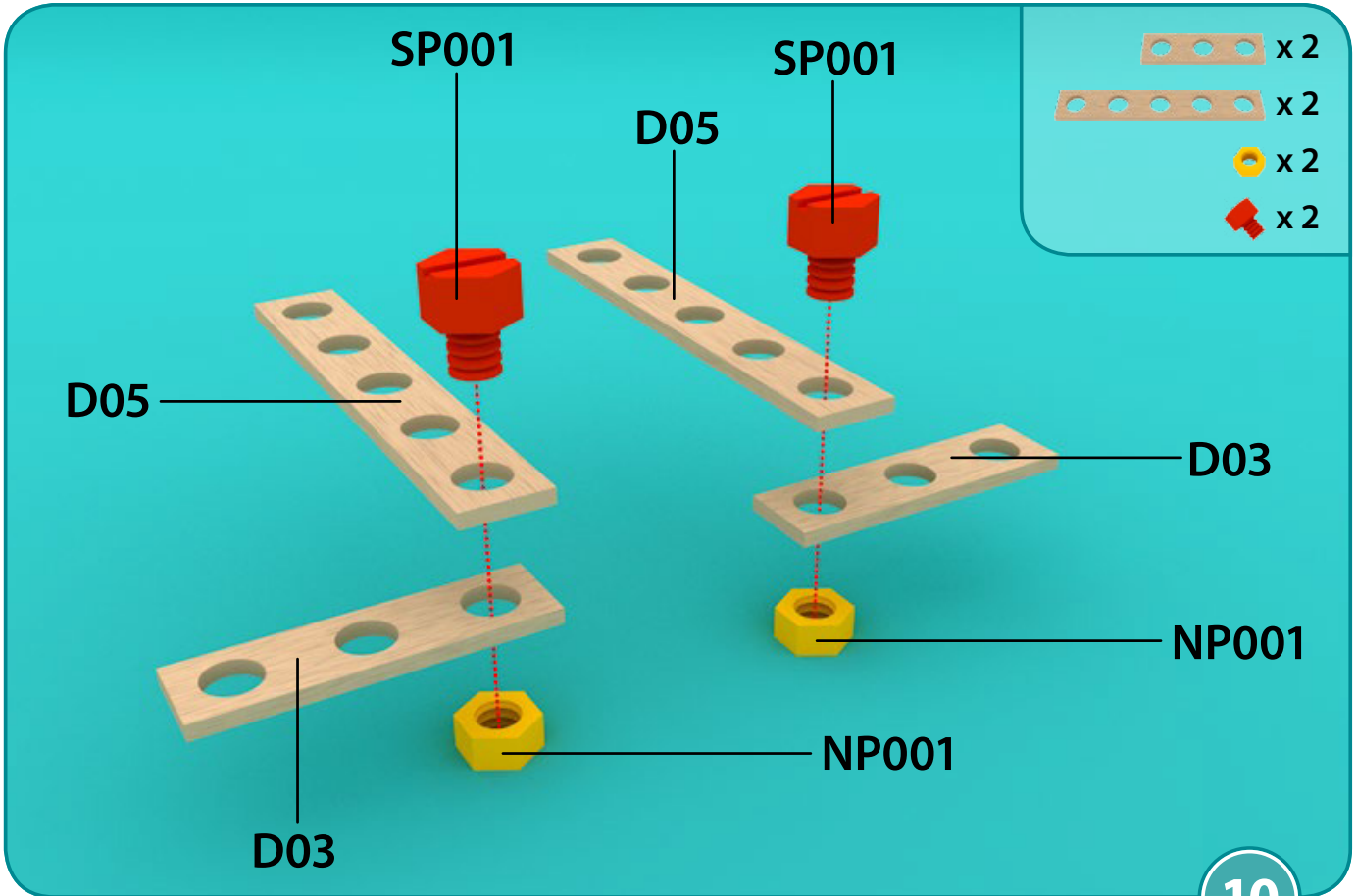

 x 2

 x 2

SP004

NP001

SP004

11

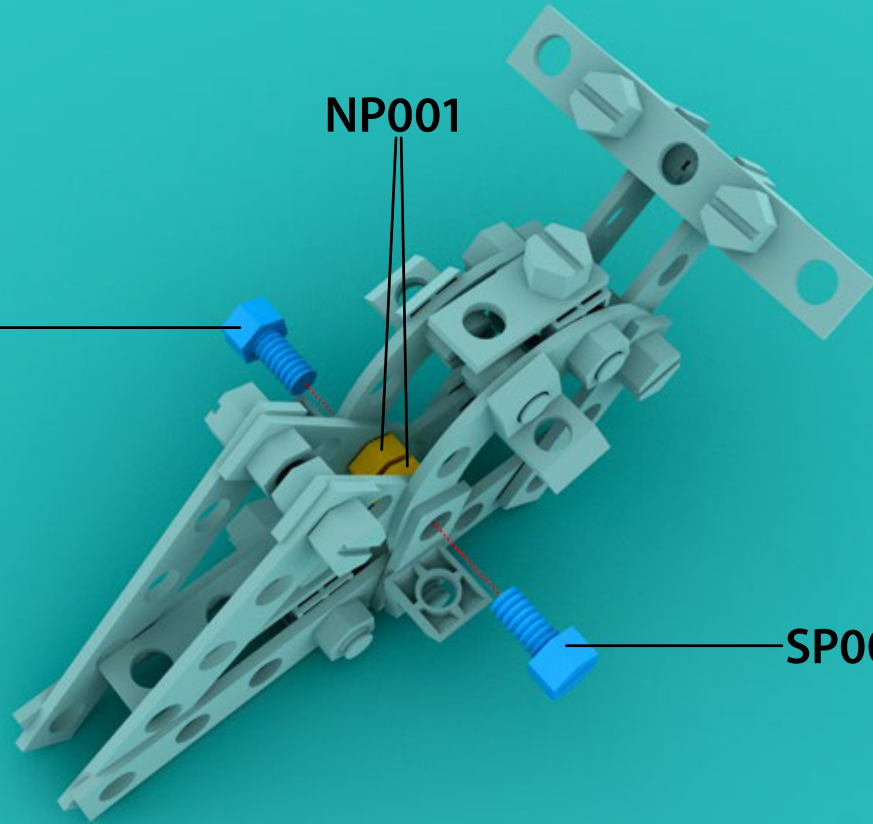

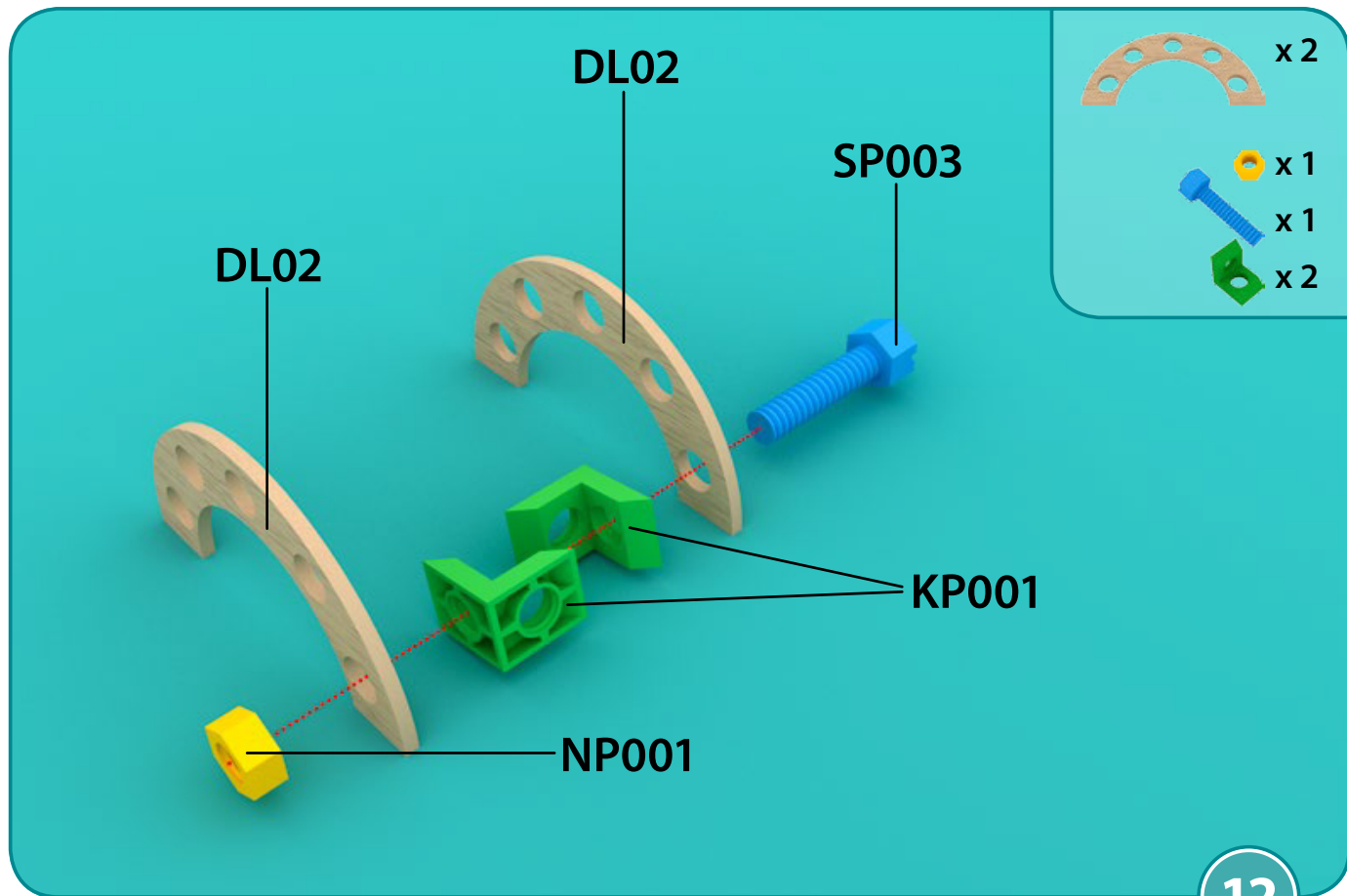

 x 1

 x 1

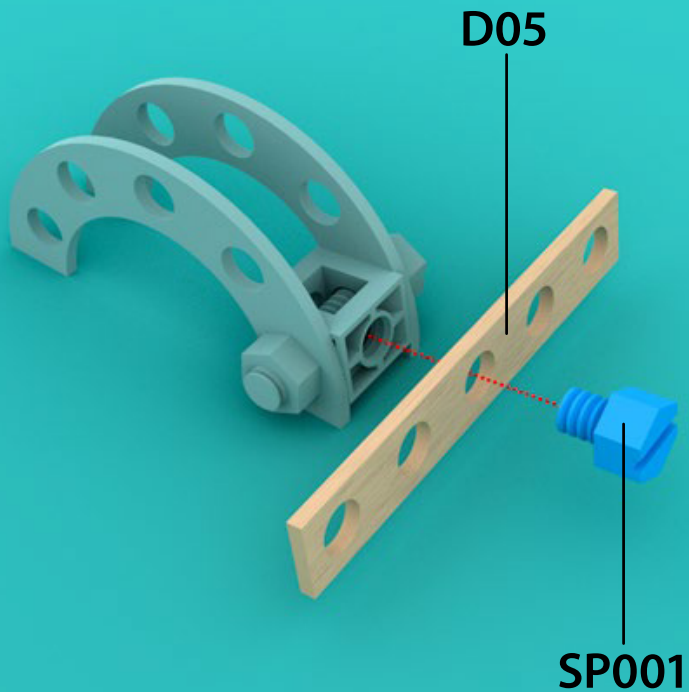

-  x 2
-  x 2

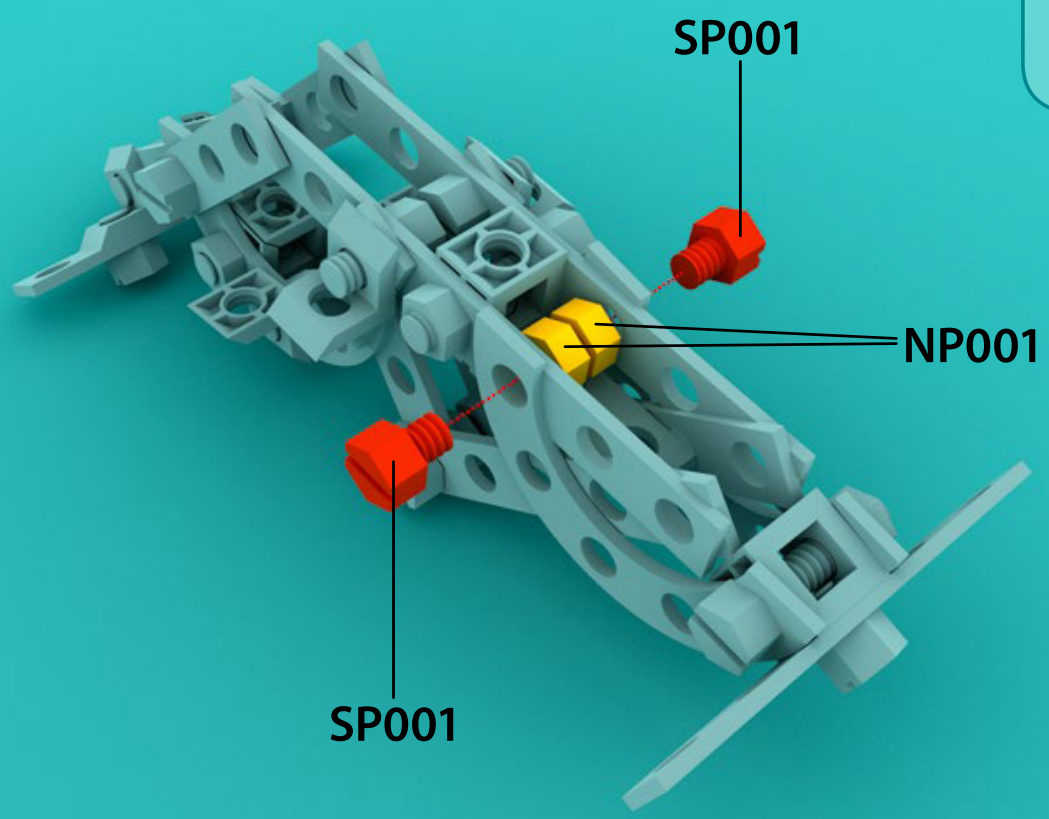



x 2



x 2



x 2

SP001

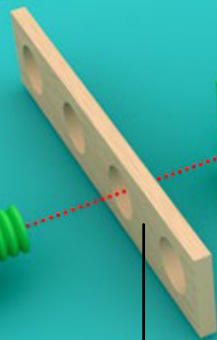
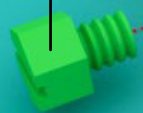

D04

KP001

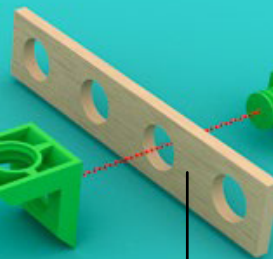
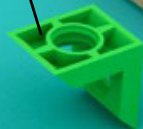

D04

SP001



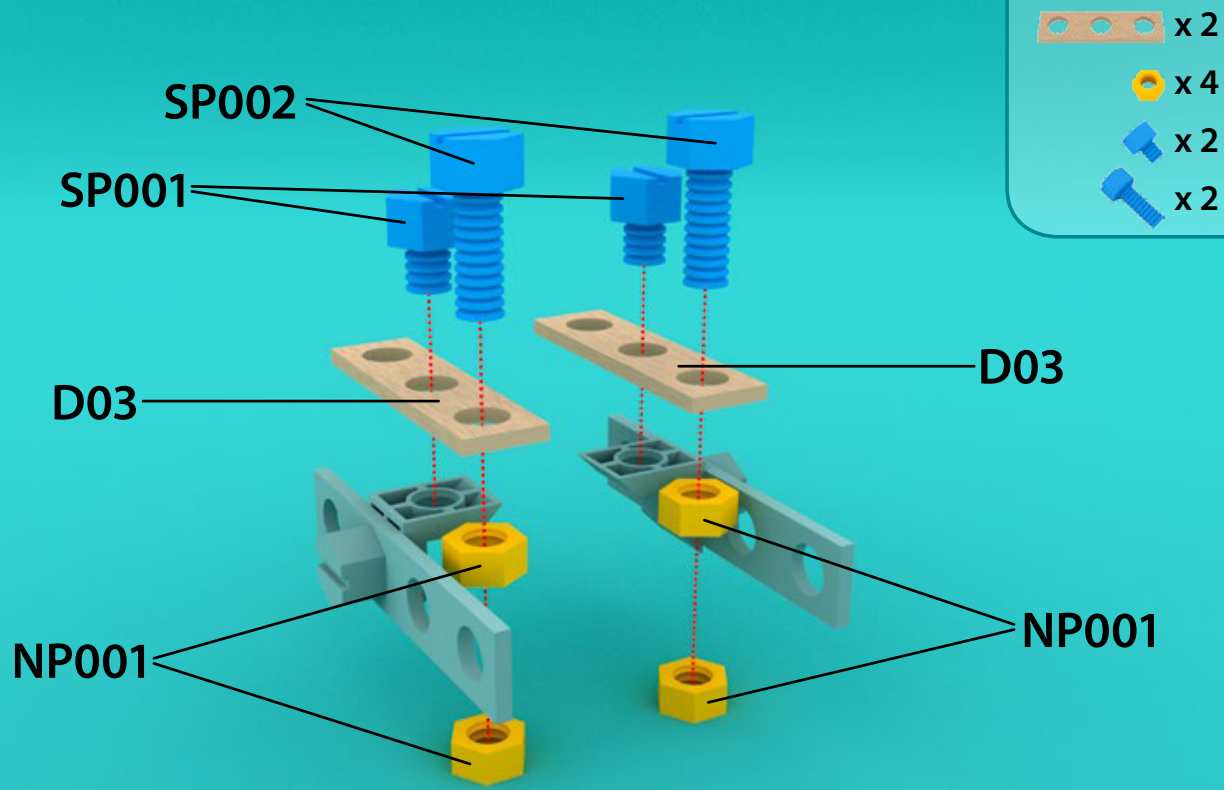

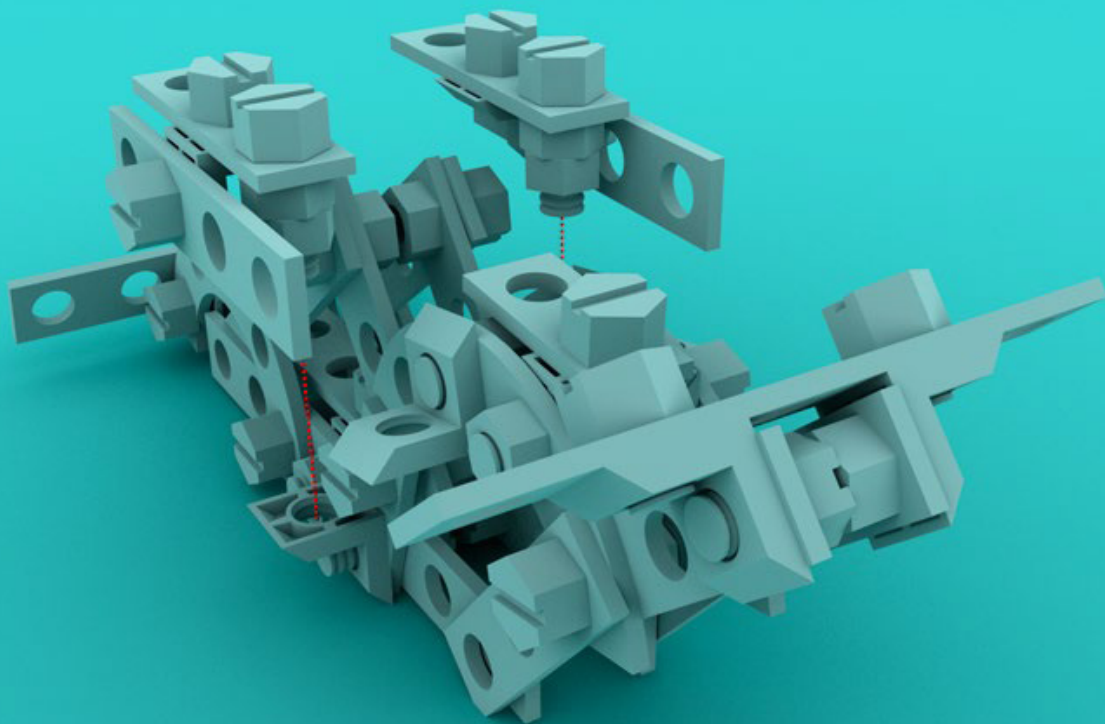

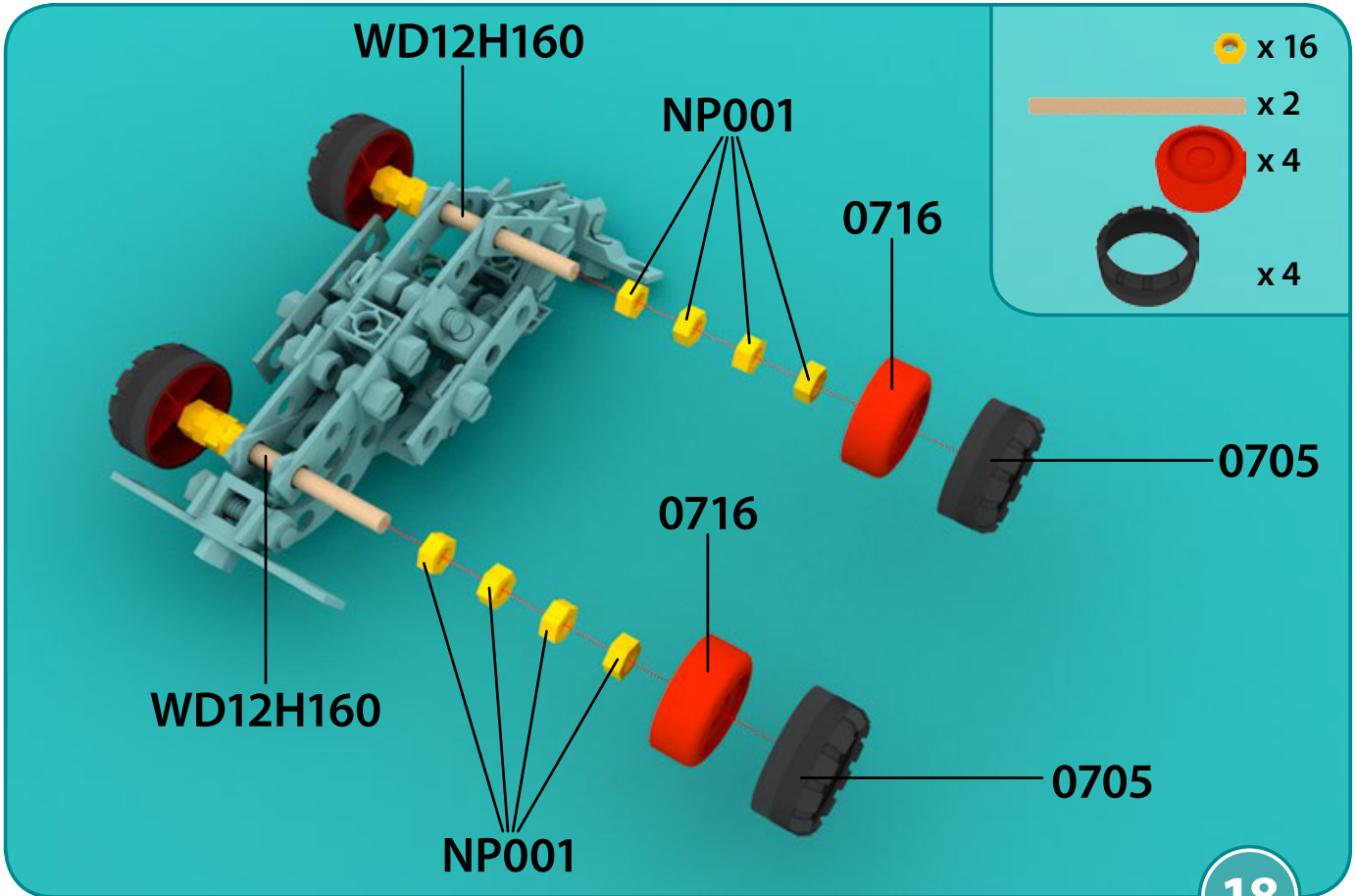

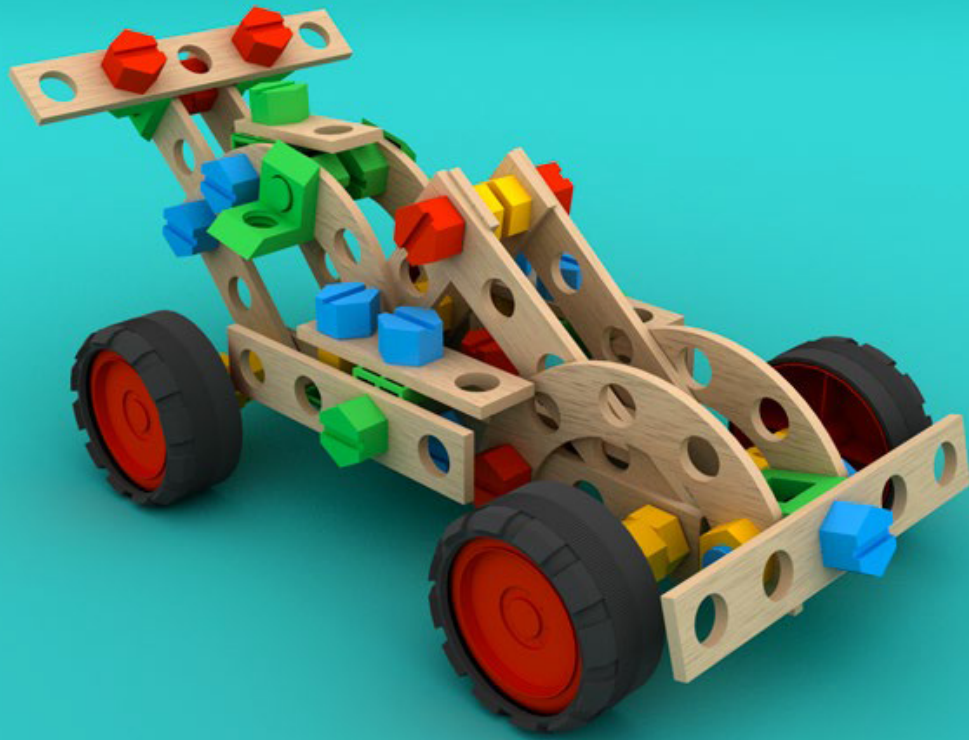





Spis elementów do montażu:



klucz x 2



D03 x 9



D04 x 2



D05 x 4



D07 x 2



DL02 X 4



WD12H160 X 2



D02 x 3



SP001 x 5



SP001 x 3



SP001 x 9



SP004 x 1



SP004 x 5



0705 X 4



0716 X 4



NP001 x 31



KP001 x 14



SP002 x 2



SP003 x 3

PL: Ostrzeżenia! Nieodpowiednie dla dzieci w wieku poniżej 3 lat. Zestaw zawiera małe elementy – niebezpieczeństwo zakrztuszenia. Prosimy zachować opakowanie ze względu na podane informacje. **EN:** Warnings! Unsuitable for children under the age of 3. Contains small parts – choking hazard. Keep the box for future reference. **DE:** Achtung! Nicht für Kinder unter 3 Jahren geeignet. Enthält kleine Teile, die verschluckt werden können – Erstickungsgefahr. Verpackung für spätere Rückfragen aufbewahren. **FR:** Attention! Ne convient pas aux enfants de moins de 3 ans. Contient des petits éléments pouvant être avalés et engendrer un risque d'étouffement. Documentation à lire et à conserver pour consultation ultérieure. **ES:** ¡Advertencia! No recomendable para niños de 3 años o menores. Peligro de asfixia – piezas pequeñas. Conserve la caja para futuras referencias. **NL:** Waarschuwing! Niet geschikt voor kinderen jonger dan drie jaar. Bevat kleine onderdelen – verstikkingsgevaar opleveren. Bewaar de verpakking, er staat belangrijke informatie op. **CZ:** Upozornění! Nevhodné pro děti do 3 let. Balení obsahuje malé dílky – nebezpečí udušení. Zachovejte prosím obal ze vzhledu na uvedené informace. **SK:** Upozornenia! Nevhodné pre deti vo veku do 3 rokov. Súprava obsahuje malé časti – hrozí nebezpečenstvo udusenía. Obal uschovajte vzhľadom na dôležité informácie, ktoré sa na ňom nachádzajú.



www.alexander.com.pl